

**RADIO RECEIVER RGB CONTROLLING LED STRIP COMMON ANODE**

Product code:

**TVRGBDSY868ST24** Syncroled Master receiver 4A

**TVRGBDSY868SL24** Syncroled Slave receiver 4A

TVRGBD000ST24 Slave receiver 4A

**TVRGBD000ST24**

Slave receiver 4A

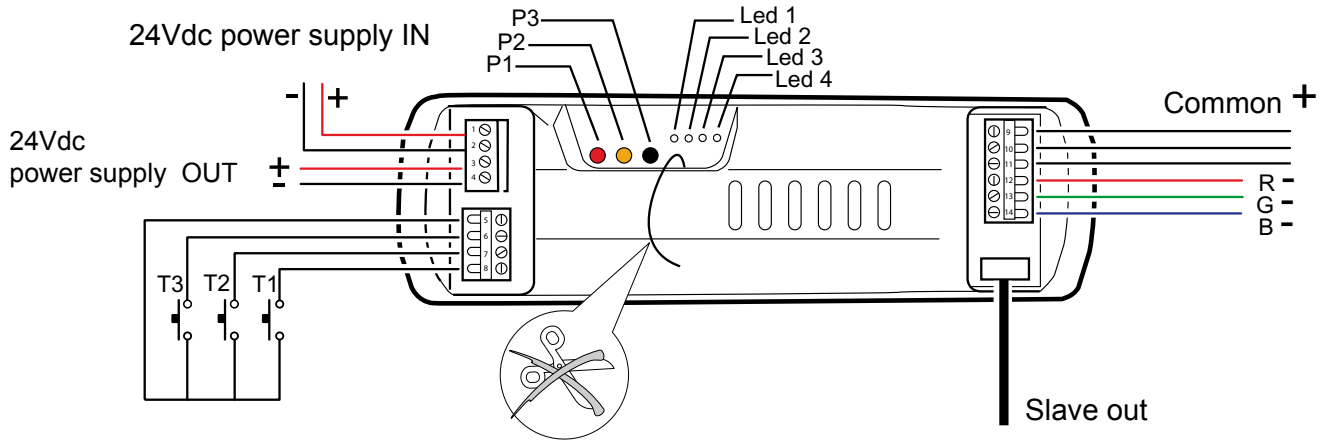

**1 - Led wiring**

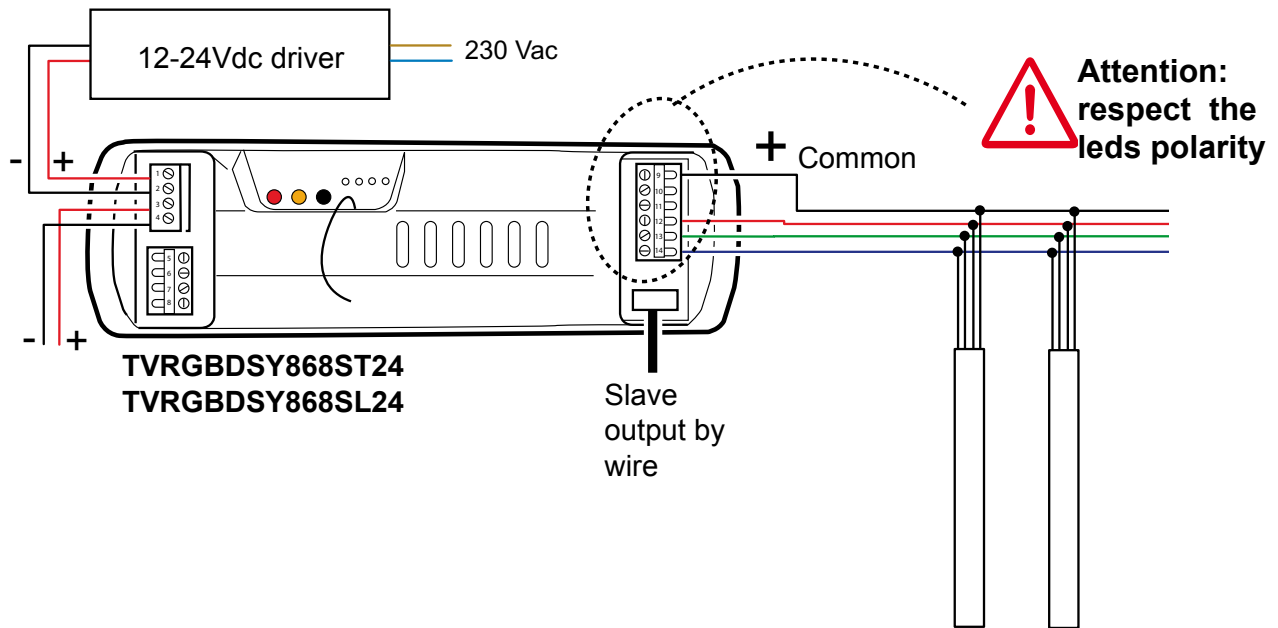

			Model number	
			T421.02	01/08/12

## 1.2 - SLAVE wiring

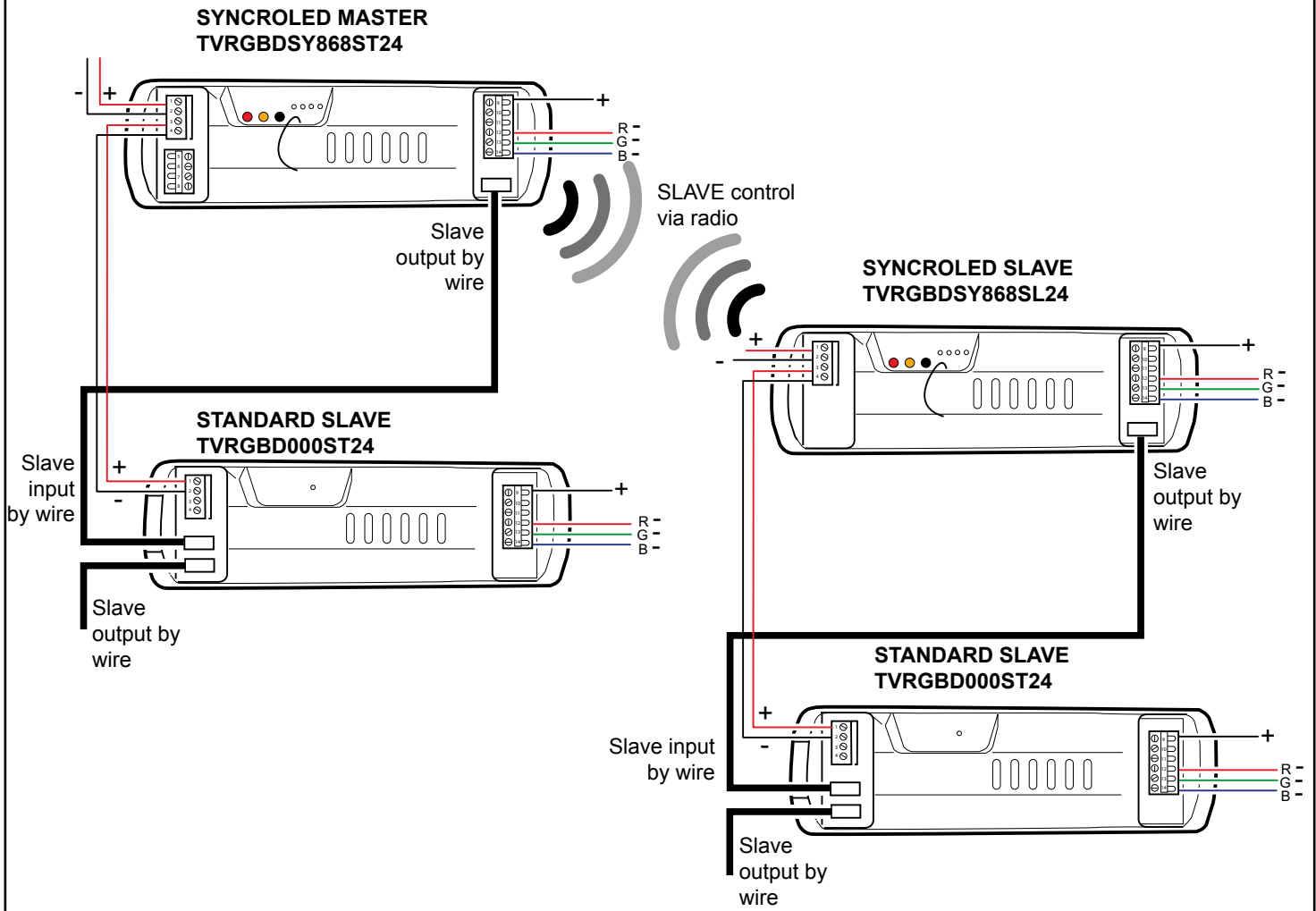

**In the field of action of a syncroled system (master+slave) it is not allowed the presence of other system syncroled (master+slave)**

## 2 - Wiring Test

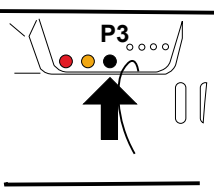

To test the LED outputs functioning press the push-button **P3**, the light turns on with a warm white colour.  
Do not hold the push button for more than 10 seconds.

## 3 - Memorisation of 7-channel transmitters with On/Off/Dimmer Colour function

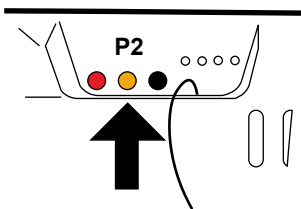

**1 time and hold down**

1- Press the push button **P2 once and hold** it down, the buzzer will make a beep and then sound continuously.

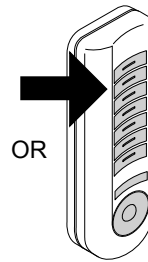
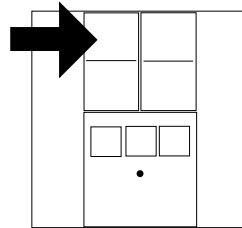

OR

Function available only for 7 or 42 channels transmitter

2- During the sound press one push button, of the 7-channel transmitter which has to be memorised, the memorization is indicated by the intermittently sound of the buzzer.

All the push-buttons of the transmitter are automatically memorized.

### 3.1 - Functioning:

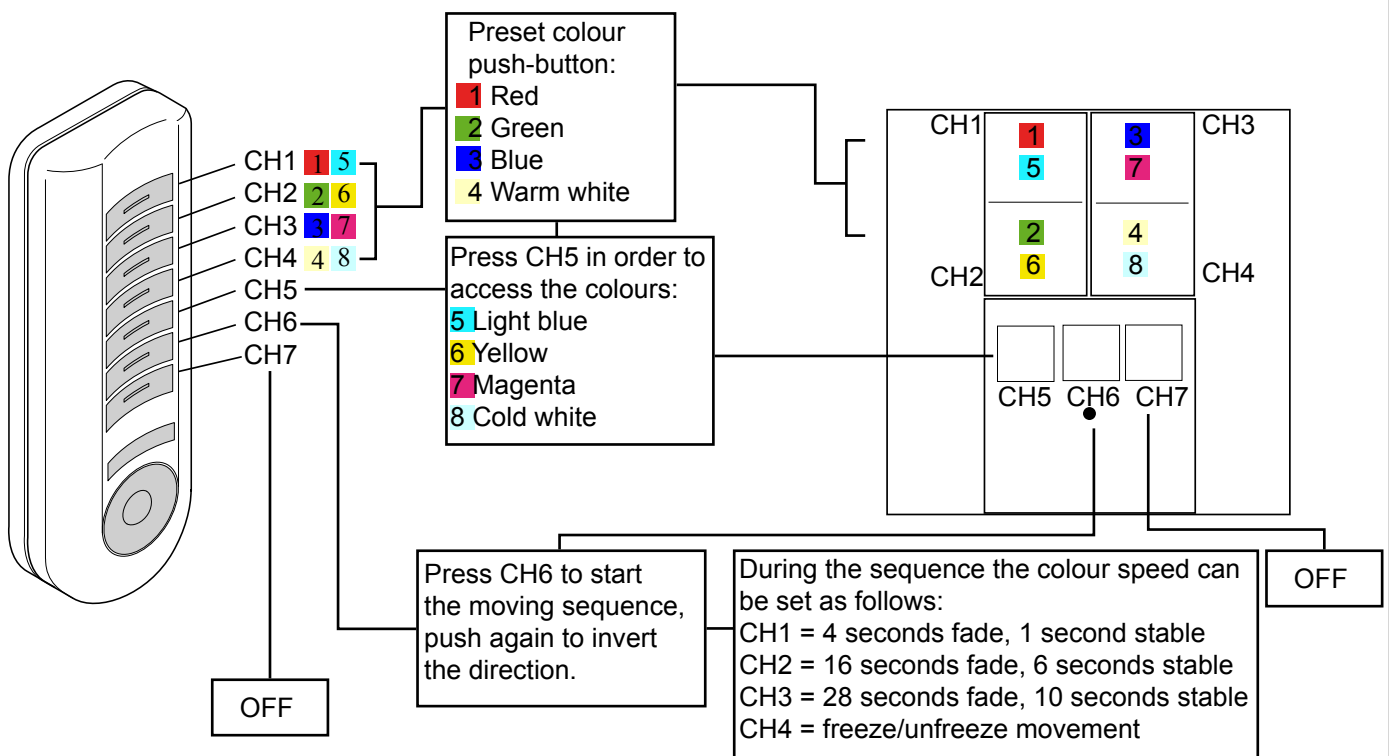

### 3.2 - How to change the pre-programmed colours in the 8 (4+4) push buttons on the transmitter

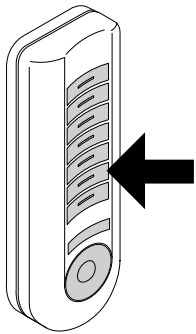

Press for more than 4 seconds the push-button CH6

choose colour

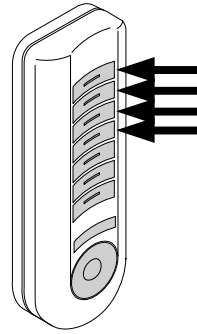

press for more than 3 seconds the push-button of the colour that you want to change

1- Press and hold down the automatic cycle push button Ch6 for more than 4 sec., the light will turn off and return on once and a second time after 4 sec. which indicates that you have entered the new colour memorization mode.

2- After you have entered the mode, the colour variation will start with a speed of 4 sec. between a colour and the next one and a pause of 1 sec. at each colour, by pressing again the push button CH6 it is possible to change immediately the rotation direction. In order to memorise the new light value, press for 3 sec. the push button to be modified, the light will turn off and return on for confirmation, afterwards you will turn back to the automatic cycle mode. If you want to leave the mode, press the turning-off push button Ch7.

### 4 - Memorisation of one transmitter push-button with Select Colour function

The colour changes at each impulse between the 8 pre-programmed colours. To turn off the colour, press the push button for more than 2 sec. At each turning-on will restart the colour that has been previously selected.

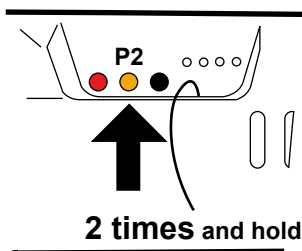

2 times and hold down

1- Press the push button **P2 twice and hold** it down, the buzzer will make a beep each time and then sound continuously.

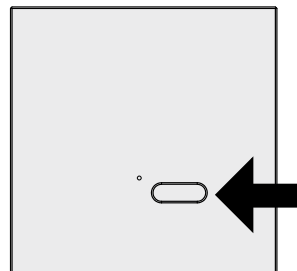

2- During the sound press the push-button which has to be memorised; the memorization is indicated by the intermittently sound of the buzzer.

Function available for all type of transmitters

### 5 - Memorisation of one transmitter push-button with ON function

The push-button memorised with On function turns on the last colour.

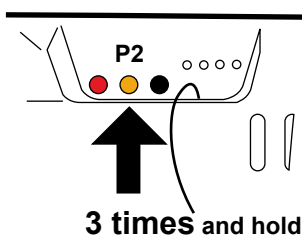

3 times and hold down

1- Press the push button **P2 three times and hold** it down, the buzzer will make a beep each time and then sound continuously.

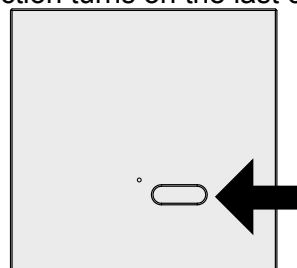

2- During the sound press the push-button which has to be memorised with ON function; the memorization is indicated by the intermittently sound of the buzzer.

Function available for all type of transmitters

## 6 - Memorisation of one transmitter push-button with OFF function

The push-button memorised with Off function turns off the light.

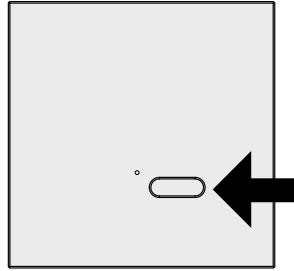
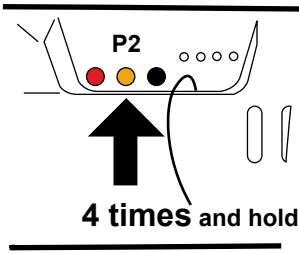

Function available for all type of transmitters

1- Press the push button **P2 four times and hold** it down, the buzzer will make a beep each time and then sound continuously.

2- During the sound press the push-button which has to be memorised; the memorization is indicated by the intermittently sound of the buzzer.

## 7 - Memorisation of one transmitter push-button with warm white On/Off/Dim function

With short impulses (<800 ms.) turn the light on and off, by holding it pressed increase or decrease the intensity.

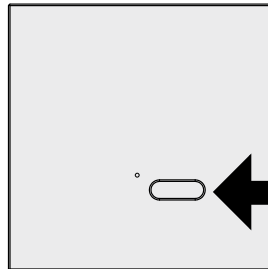
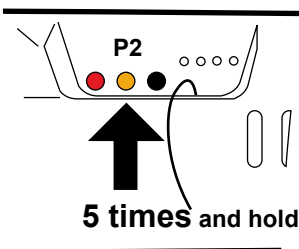

Function available for all type of transmitters

1- Press the push button **P2 five times and hold** it down, the buzzer will make a beep each time and then sound continuously.

2- During the sound press the push-button which has to be memorised; the memorization is indicated by the intermittently sound of the buzzer.

## 8 - To memorise one transmitter push-button with cold white On/Off/Dim function

With short impulses (<800 ms.) turn the light on and off, by holding it pressed, increase or decrease the intensity.

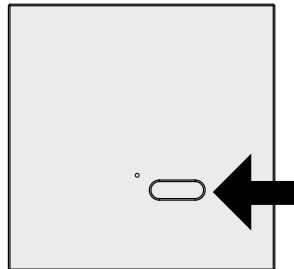
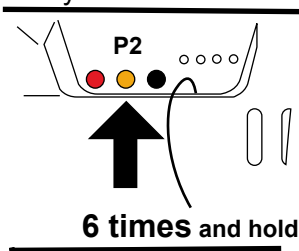

Function available for all type of transmitters

1- Press the push button **P2 six times and hold** it down, the buzzer will make a beep each time and then sound continuously.

2- During the sound press the push-button which has to be memorised; the memorization is indicated by the intermittently sound of the buzzer.

## 9 - Memorisation of 4-, 7- and 42-channel transmitters with SCENE function

The memorised transmitter displays the programmed scene:

- a) Pushbutton Ch1: Start colour scene 1
- b) Pushbutton Ch2: Start colour scene 2
- c) Pushbutton Ch3: Start colour scene 3
- d) Pushbutton Ch4: Start colour scene 4

In order to turn the current scene off press one of the push buttons CH1,CH2, CH3 or CH4 for more than 2 seconds; for the 7 channel transmitters it is possible to turn the sequence off by pressing the push button CH7. The colours sequences must be memorised before the displaying by using an USB transmitter (TVTXQ868U07).

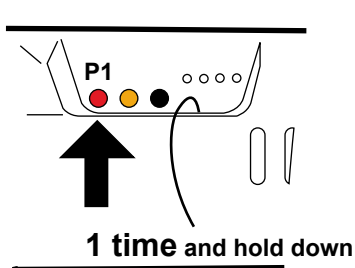

1- Press the push button **P1 once and hold** it down, the buzzer will make a beep each time and then sound continuously.

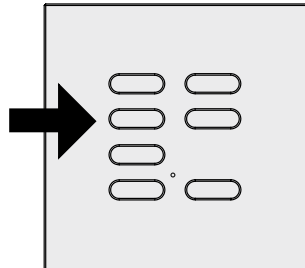

2- During the sound press the push button of the transmitter which has to be memorised, the memorization is indicated by the intermittently sound of the buzzer. All the 4 push-buttons of the transmitter are automatically memorized.

Function available for all type of transmitters



In the 7 and 42 channels transmitter, the push buttons CH5 and CH6 are disabled.

## 10 - To copy a function of transmitter push-button to a new transmitter

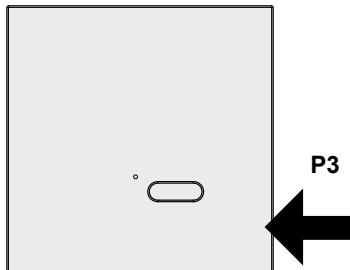

1- Press the button **P3** located inside the **already memorized transmitter**. The enabled receiver sound continuously.

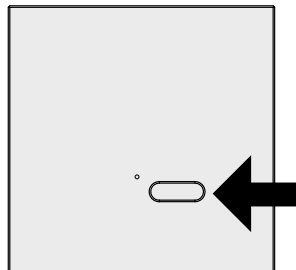

2- Within 5 seconds press a push-button of the **already memorized transmitter** from which the function has to be copied. The buzzer will interrupt the sound for 1 sec., and then carry on for 5 seconds.

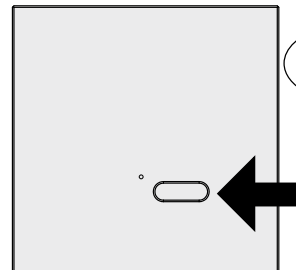

3- During the sound press the push-button of the **new transmitter** which has to be memorised; the memorization is indicated by the intermittently sound of the buzzer.

Function available for all type of transmitters

## 11 - Receiver management via PC using series TVTXQ868U07 transmitters.

Remote control dedicated exclusively to scene management using RGBPC software



**See software manuals**

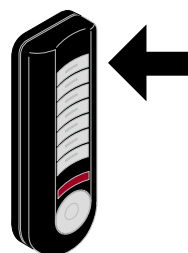
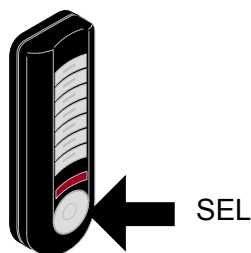
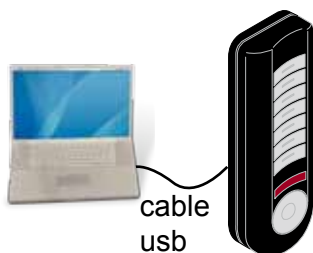

- 1- Connect the USB transmitter to the PC.
- 2- Open the RGBPC management software.
- 3- Insert the receiver's serial number into the relevant field.
- 4- Program the scenes.
- 5- Disconnect the remote control from the PC.



- It is possible to send scenes with the USB transmitter connected to the PC if you are in the vicinity of the installation (see software manual RGBPC).
- It is possible to send scenes with the transmitter disconnected.

Each one of the 7 buttons on the USB transmitter corresponds to a serial number and therefore to a receiver



Receiver: 00001 - Scene: 1



2



3



4



.....

Receiver: 00007 - Scene: 1



2



3



4



- 7- Press the button that corresponds to the receiver to which you wish to send the scenes. The Led on the transmitter will flash rapidly while data is being sent and after the transmission has ended it will flash slowly twice.

(If the Led only flashes twice it means that there is no data available to send)

- 8- The Leds connected to the receiver to which you are transmitting the data will glow yellow during transmission and then glow green if the transmission has been successful or red if errors have been detected (in this case repeat the transmission).

### 11.1 - Memorize a transmitter button in 7 USB channels.

Note. Only when you do not know the receiver's serial number:

- Carry out the scene memorization procedure from points 1 to 5 in the preceding paragraph inserting a casual number to be associated with a button on the remote control.
- Memorize the remote control's programmed button in the receiver following points 1 and 2 as laid out below.
- After memorizing the user can send the scenes stored in the remote control by simply pressing the memorized button.

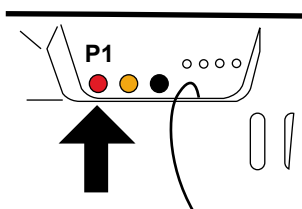

**2 times and hold down**

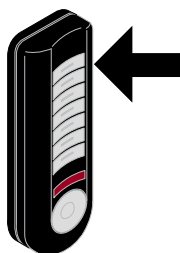

- 1- Press the push button **P1 twice and hold** it down, the buzzer will make a beep each time and then sound continuously.

- 2- During the sound press the push-button which has to be memorised; the memorisation is indicated by the intermittently sound of the buzzer.

## 11.2 - To delete a push-button of 7-channels USB transmitter

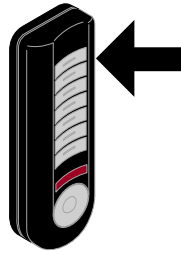
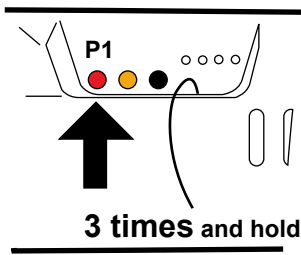

The push-buttons of the transmitter programmed via PC with the USB serial number of the receiver can not be deleted.

1- Press the push button **P1 three time and hold** it down, the buzzer will make a beep each time and then sound slowly and intermittently.

2- During the sound press the push-button which has to be deleted; the deletion is indicated by the continuously sound of the buzzer.

## 11.3 - To delete all 7-channels USB transmitter

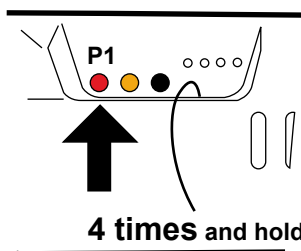

The push-buttons of the transmitter programmed via PC with the USB serial number of the receiver can not be deleted.

1- Press the push button **P1 four time and hold** it down, the buzzer will make a beep each time and then sound quickly and intermittently.  
2- Hold down the push button for 10 sec., after this 10 sec. the buzzer will sound continuously by indicating that the whole memory has been cancelled.

## 12 - To delete a transmitter

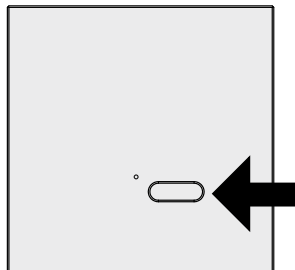
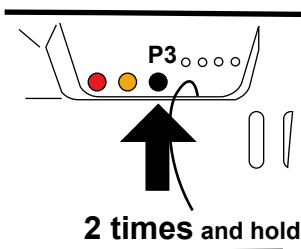

With this procedure the USB transmitter does not be deleted.

1- Press the push button **P3 two time and hold** it down, the buzzer will make a beep each time and then sound slowly and intermittently.

2- During the sound press the push-button which has to be deleted; the deletion is indicated by the continuously sound of the buzzer.

## 12.1 - To delete all transmitter

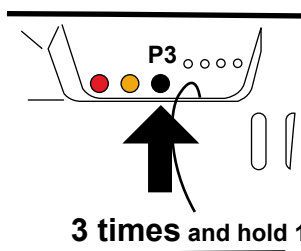

With this procedure the USB transmitter does not be deleted.

1- Press the push button **P3 three time and hold** it down, the buzzer will make a beep each time and then sound quickly and intermittently.  
2- Hold down the push button for 10 sec., after this 10 sec. the buzzer will sound continuously by indicating that the whole memory has been cancelled.



### 13 - Memory activation/ deactivation of the last value of light intensity

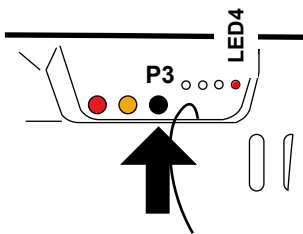

**4 times and hold 10s**

- 1- Push the push button **P3 four times and hold** it down for 10 seconds.
- 2- After these 10 seconds:
  - the light will flash 2 times and led 4 turn on if the function will be activated;
  - the light will flash 3 times and led 4 turn off if the function will be deactivated.

### 14 - Colour settings reset

This procedure will restore the default color settings

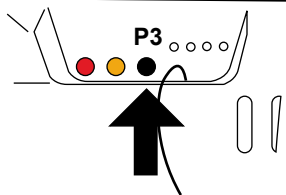

**1 time and hold 10s**

- Push the push-button **P3 once and hold** it down for 10 seconds. The light turns on with a warm white colour and after 10 sec. it will flash once. The light will turn off at the release of the push button.



**With this procedure the transmitter does not be deleted**

### 15 - Functioning with manual push buttons in the Master receiver

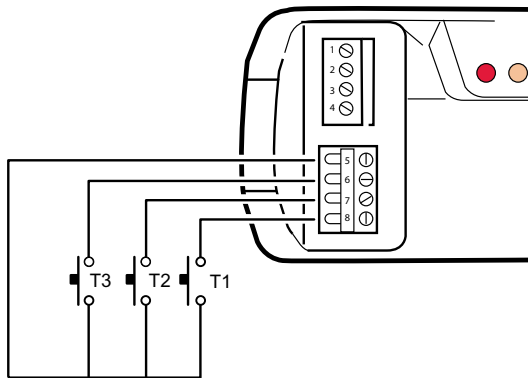

- Arrange three manual push buttons for a wire-control with the following functions:

**a) Push button T1**

It turns on the lights at the value previous the turning-off if the memory of the last light value is active, you can select with impulses in sequence one of the 8 colour values.

**b) Push button T2**

Activates an automatic cycle.

- Press the push button T2, the turning-off and returning-on of the lights indicates that you have entered the mode, release the push button in order to start the cycle.

- By re-pressing it, you will stop the rotation direction at the present colour value.

- By re-pressing it you will reactivate the rotation direction.

- By re-pressing it for more than 2 sec. you will change the rotation direction.

To turn off press T3.

**c) Push button T3: Turning-off**

## 16 - SLAVE MODULE

The synchroled MASTER receivers can control synchroled SLAVE receivers and standard SLAVE receivers via wire. At each SLAVE device it is possible to connect unlimited other SLAVE devices via wire. In the synchroled SLAVE receivers it is possible to memorise only one synchroled MASTER device. **In the field of action of a synchroled system (master+slave) it is not allowed the presence of other system synchroled (master+slave)**

## 17 - Programming push buttons on the housing (SLAVE)

P1 (red): Memorisation and deletion of Master  
P2 (orange): Activation/ Deactivation signal booster  
P3 (black): LED outputs functioning test

## 18 - Memorisation of the synchroled MASTER device into the SLAVE device

### synchroled slave

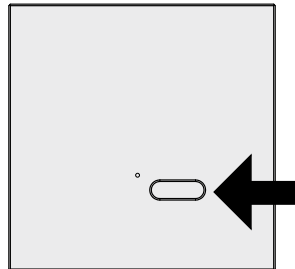
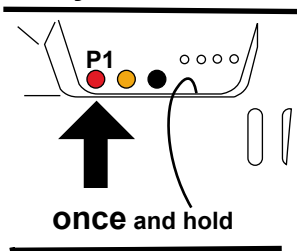

Proceeding with the memorization with colour in movement it not necessary to provoke a transmission; during the colour variations the master executes transmissions with regular intervals.

1- Enable the memorisation of the synchroled SLAVE receiver by pressing the push button **P1 once**, the buzzer will emit a sound continuously.

2- During the sound you have to provoke a transmission from the synchroled MASTER to the SLAVE. The transmission can be provided either from a wired push button (T1, T2 or T3), by pressing test push button P3 or by pressing the push button of a transmitter already memorised into the synchroled master. The memorization is signalled by the intermittent sound of the buzzer of the synchroled slave.

## 19 - Deletion of the synchroled MASTER device from the SLAVE device

### synchroled slave

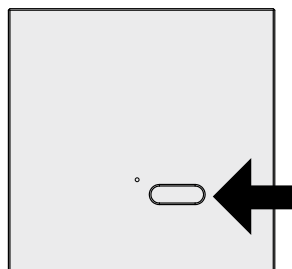
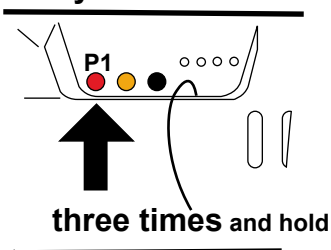

1- Press the push-button **P1 three times and hold** it down, the buzzer will make a beep at each pressure and than sound quickly and intermittently.

2- Hold down the push button for 10 sec., after this 10 sec. the buzzer will sound continuously by indicating that the whole memory has been cancelled.

## 20 - Enabling/ Disabling of the “signal booster” function in the synchroled SLAVE device

The SLAVE receiver repeats the radio signal sent by the MASTER device. The enabling of this function is indicated by the turning on of LED 4.

### synchroled slave

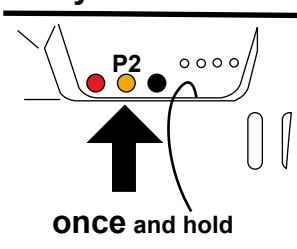

### synchroled slave

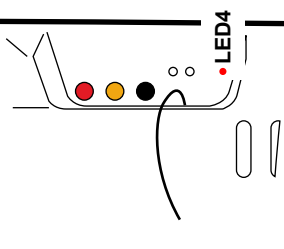

1- Press **once and hold** the push button P2 for at least 3 seconds.

2- If the function has been enabled the light will flash and LED 4 remains turned on. If the function has been disabled the light will flash and LED 4 remains turned off.

## Mounting

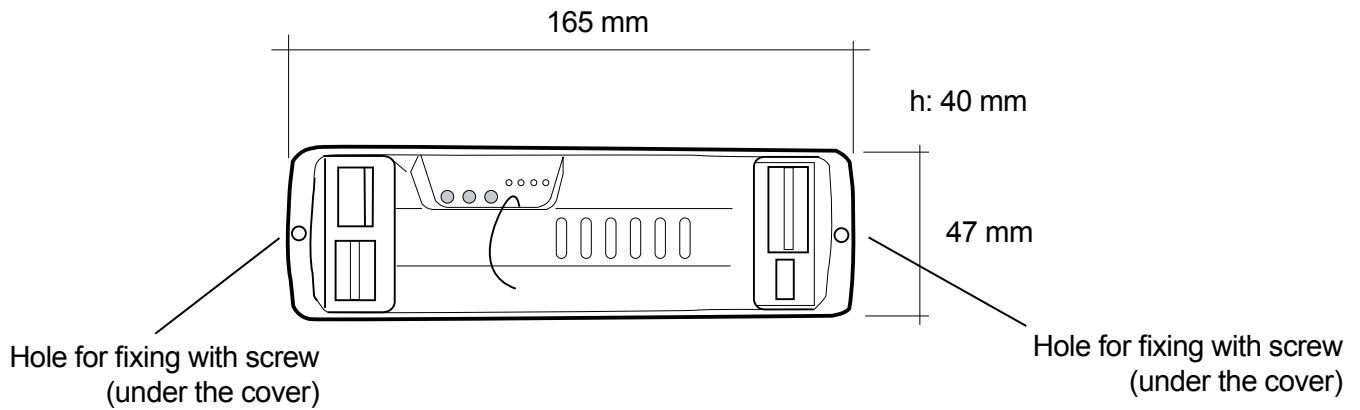

Flat surface mounting

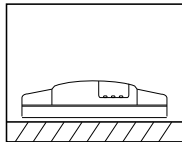

Ceiling mounting

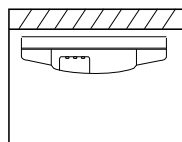

Wall mounting

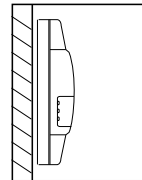

## Warning



**Connect the power supplier and the LED in a correct way to the receiver before connecting the power supplier to the electricity network.**

**A faulty connection of the LED diodes (polarity inversion) could damages them, therefore pay attention during their connection by respecting the polarity. The general power supply of the device has to be by a power supplier which can supply the power and tension needed. The power supply must be compliant with IEC60950-1 and must be protected against the short circuit and overvoltage.**

**At the power-on-reset the condition previous the turning-off will be resumed.**

**In the view of a constant development of their products, the manufacturer reserves the right for changing technical data and features without prior notice.**

**The product must not be enclosed or placed with insulating material such as glass wool, polystyrene or similar materials. Let the housing to be well-ventilated.**

## TECHNICAL SPECIFICATIONS

-Power supply 12 Vdc to 24 Vdc

-Max. power for each output 3 x 4A

-Cable sections in input and output 2,5 mm<sup>2</sup> with maximum load

The connection cables must have a section suitable to the maximum load applied to the output, and to the additional devices connected to the input.

-Reception frequency 868.3 MHz

-Intermediate frequency IF 10.7 MHz

-Sensibility (finely tuned signal) 1  $\mu$ V

-Operating temperature range -20° - +50°C

- Possibility to memorise up to 42 standard transmitters.

- Possibility to memorise up to 8 USB transmitters.